

# Data Sheet



Article number: 20379266

Description: E+G Handwheel  
GN 323-80-K10-R

## Measures

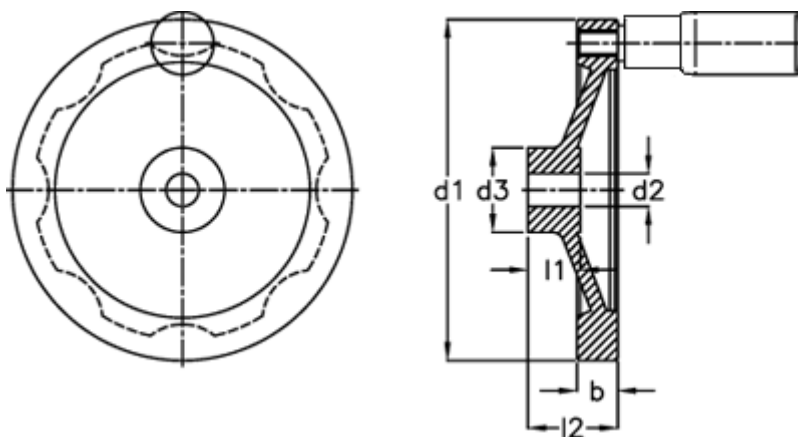

b = 13.0

d1 = 80

d2 H7 = 10

d3 = 26

Handle = 16

l1 = 16

l2 = 26